



X1 Series User Manual

2.5kw - 3.3kw



EN



Solax Power Network Technology (Zhe jiang) Co., Ltd.

No.288 Shizhu Road, Tonglu Economic Development Zone,
Tonglu City, Zhejiang Province, China.

Tel: +86 0571-56260011

E-mail: info@solaxpower.com

Copyright Declaration

The copyright of this manual belongs to Solax Power Network Technology (Zhe jiang) Co.,Ltd. Any corporation or individual should not plagiarize, partially or fully copy(including software,etc.), and no reproduction or distribution of it in any form or by any means. All rights reserved. Solax Power Network Technology (Zhe jiang) Co.,Ltd. reserves the right of final interpretation.

Contents

1 NOTES ON THIS MANUAL	01
1.1 SCOPE OF VALIDITY	01
1.2 TARGET GROUP	01
1.3 SYMBOLS USED	01
2 SAFETY	02
2.1 APPROPRIATE USAGE	02
2.2 IMPORTANT SAFETY INSTRUCTIONS	04
2.3 PE CONNECTION AND LEAKAGE CURRENT	06
2.4 EXPLANATION OF SYMBOLS	07
3 INTRODUCTION	08
3.1 BASIC FEATURES	08
3.2 TERMINALS OF PV INVERTER	08
3.3 DIMENSION AND WEIGHT	09
4 TECHNICAL DATA	10
4.1 DC INPUT	10
4.2 AC OUTPUT	10
4.3 EFFICIENCY, SAFETY AND PROTECTION	11
4.4 GENERAL DATA	11
5 FUNCTION	12
5.1 CHECK FOR TRANSPORTATION DAMAGE	12
5.2 PACKING LIST	12
5.3 INSTALLATION PRECAUTION	13
5.4 INSTALLATION STEPS	14
5.5 CONNECTION OF THE Inverter	15
5.6 START THE INVERTER	25
6 OPERATION METHOD	26
6.1 INDICATOR PANEL	26
6.2 LCD STRUCTURE	27
6.3 LCD DISPLAY	28
7 TROUBLESHOOTING	32

7.1 TROUBLESHOOTING 32
 7.2 MAINTENANCE 34
8 DECOMMISSIONING 35
 8.1 DECOMMISSIONING 35
 8.2 STORAGE AND TRANSPORTATION 35
 8.3 DISPOSAL 35

1 Notes on this Manual

1.1 Scope of validity

This installation guide describes the assembly, installation, commissioning, maintenance and failure search of the following series inverter.

X1-2.5-S-D(L)	X1-3.0-S-D(L)	X1-3.3-S-D(L)
X1-2.5-S-N(L)	X1-3.0-S-N(L)	X1-3.3-S-N(L)

Note: **"2.5"** means 2.5kW.

"S" means "single" or one MPPT string.

"D" means with "DC Switch", **"N"** means without "DC Switch",

"L" means with "LCD display".

Please store this manual where it will be accessible at all times.

1.2 Target Group

This manual is for qualified personnel. The tasks described in this manual may only be performed by qualified personnel.

1.3 Symbols Used

The following types of safety instructions and general information appear in this document described as below.



DANGER!

Danger indicates a hazardous situation which, if not avoided, will result in death or serious injury.



WARNING!

Warning indicates a hazardous situation which, if not avoided, could result in death or serious injury.



CAUTION!

Caution indicates a hazardous situation which, if not avoided, could result in death or serious injury.



NOTE!

Note provides tips that are valuable for the optimal operation of your product.

2 Safety

2.1 Appropriate Usage

The X1 Series PV inverters can convert the DC current of the PV generator into AC current and feed it into the public grid.

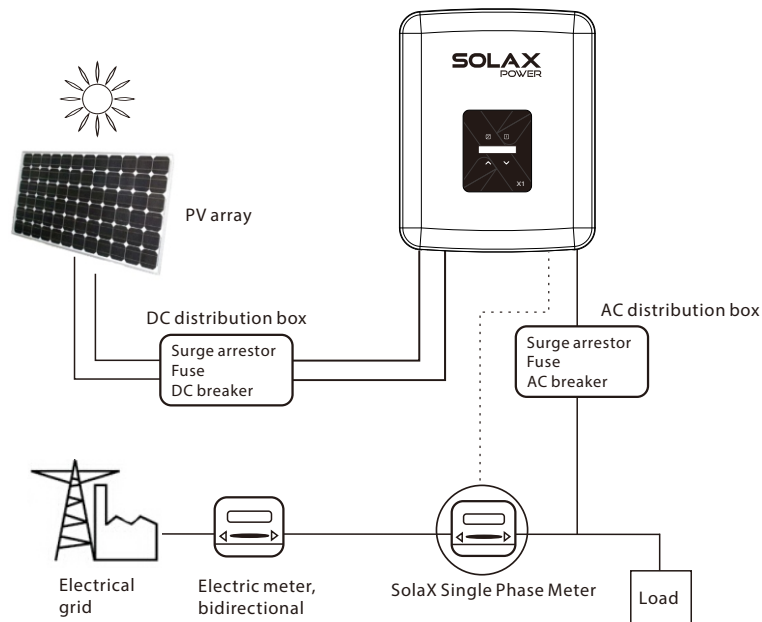

CAUTION !

For X1-2.5-S-N(L), X1-3.0-S-N(L), X1-3.3-S-N(L), external DC breaker must be connected on the PV side.

► Surge protection devices (SPDs) for PV installation



WARNING !

Over-voltage protection with surge arresters should be provided when the PV power system is installed. The grid connected inverter is fitted with SPDs in both PV input side and MAINS side.

Lightning will cause direct strike or damage from the impact of the surge.

Induced surges are the most likely cause of lightning damage in majority of installations, especially in rural areas where electricity is usually provided by long overhead lines. Surge may be included on both the PV array conduction and the AC cables leading to the building.

Specialists in lightning protection should be consulted during the end use application. Using appropriate external lightning protection, the effect of a direct lightning strike into a building can be mitigated in a controlled way, and the lightning current can be discharged into the ground.

Installation of SPDs to protect the inverter against mechanical damage and excessive stress include a surge arrester in case of a building with external lightning protection system (LPS) when separation distance is kept.

To protect the DC system, surge suppression device (SPD type2) should be fitted at the inverter end of the DC cabling and at the array located between the inverter and the PV generator, if the voltage protection level (VP) of the surge arresters is greater than 1100V, an additional SPD type 3 required for surge protection for electrical devices.

To protect the AC system, surge suppression devices (SPD type2) should be fitted at the main incoming point of AC supply (at the consumer's cutout), located between the inverter and the meter/distribution system; SPD (test impulse D1) for signal line according to EN 61632-1.

All DC cables should be installed to provide as short a run as possible, and positive and negative cables of the string or main DC supply should be bundled together. Avoiding the creation of loops in the system. This requirement for short runs and bundling includes any associated earth bundling conductors.

Spark gap devices are not suitable to be used in DC circuits once conducting, they won't stop conducting until the voltage across their terminals is typically less than 30 volts.

2.2 Important Safety Instructions

DANGER!
Danger to life due to the high voltage of the inverter!

- All work must be carried out by qualified electrician.
- The appliance is not to be used by children or persons with reduced physical sensory or mental capabilities, or lack of experience and knowledge, unless they have been given supervision or instruction.
- Children should be supervised to ensure that they do not play with the appliance.

CAUTION!
Danger of burn injuries due to hot enclosure parts!

- During operation, the upper lid of the enclosure and the enclosure body may become hot.
- Only touch the lower enclosure lid during operation.

CAUTION!
Possible damage to health as a result of the effects of radiation!

- Do not stay closer than 20 cm to inverter for any length of time.

NOTE!
Grounding the PV generator.

- Comply with the local requirements for grounding the PV modules and the PV generator. SolaX recommends connecting the generator frame and other electrically conductive surfaces in a manner which ensures continuous conduction and ground these in order to have optimal protection of system and persons.

WARNING!

- Ensure input DC voltage \leq Max. DC voltage. Over voltage may cause permanent damage to the inverter or other losses, which will not be included in warranty!

WARNING!

- Authorized service personnel must disconnect both AC and DC power from X1 series before attempting any maintenance or cleaning or working on any circuit connected to the series.

WARNING !
 Do not operate the inverter when the device is running.

WARNING !
 Risk of electric shock!

- Prior to the application, please read this section carefully to ensure correct and safe application. Please keep the user manual properly.
- Use only attachments recommended or sold by SolaX. Otherwise may result in a risk of fire, electric shock, or injury to person.
- Make sure that existing wiring is in good condition and the wire is not undersized.
- Do not disassemble any parts of inverter which are not mentioned in installation guide. It contains no user-serviceable parts. See Warranty for instructions on obtaining service. Attempting to service the X1 Series inverter yourself may result in a risk of electric shock or fire and will void your warranty.
- Keep away from flammable, explosive materials to avoid fire disaster.
- The installation place should be away from humid or corrosive substance.
- Authorized service personnel must use insulated tools when installing or working with this equipment.
- PV modules shall have an IEC 61730 class A rating.
- Never touch either the positive or negative pole of PV connecting device. Strictly prohibit touching both of them at the same time.
- The unit contains capacitors that remain charged to a potentially lethal voltage after the MAINS and PV supply has been disconnected.
- Hazardous voltage will present for up to 5 minutes after disconnection from power supply.
- CAUTION-RISK of electric shock from energy stored in capacitor. Never operate on the solar inverter couplers, The MAINS cables, PV cables or the PV generator when power is applied. After switching off the PV and Mains, always wait for 5 minutes to let the intermediate circuit capacitors discharge before you unplug DC and MAINS couplers.
- When accessing the internal circuit of solar inverter, it is very important to wait 5 min before operating the power circuit or demounting the electrolyte capacitors inside the device. Do not open the device before hand since the capacitors require time to sufficiently discharge!
- Measure the voltage between terminals UDC+ and UDC- with a multi-meter (impedance at least 1Mohm) to ensure that the device is discharged before beginning work (35VDC) inside the device.

2.3 PE Connection and Leakage Current

- The inverter incorporates a certified internal Residual Current Device (RCD) in order to protect against possible electrocution and fire hazard in case of a malfunction in the cables or inverter. There are two trip thresholds for the RCD as required for certification (IEC 62109-2:2011). The default value for electrocution protection is 30mA, and for slow rising current is 300mA.
- If an external RCD is required by local regulations, check which type of RCD is required for relevant electric code. It recommends using a type-A RCD. The recommended RCD values is 100mA or 300mA unless a lower value is required by the specific local electric codes. When required by local regulations, the use of an RCD type B is permitted.

	WARNING ! High leakage current! Earth connection essential before connecting supply.
---	---

- Incorrect grounding can cause physical injury, death or equipment malfunction and increase electromagnetic.
- Make sure that grounding conductor is adequately sized as required by safety regulations.
- Do not connect the ground terminals of the unit in series in case of a multiple installation. This product can cause current with a d.c component, Where a residual current operated protective (RCD) or monitoring (RCM) device is used for protection in case of direct or indirect contact, only an RCD or RCM of type B is allowed on the supply side of this product.

➤ For United Kingdom:

- The installation that connects the equipment to the supply terminals shall comply with the requirements of BS 7671.
- Electrical installation of PV system shall comply with requirements of BS 7671 and IEC 60364-7-712.
- No protection settings can be altered.
- Installer shall ensure that equipment is so installed and operated to maintain at all times compliance with the requirements of ESQCR22(1)(a).

➤ For Australia and New Zealand:

- Electrical installation and maintenance shall be conducted by licensed electrician and shall comply with Australia National Wiring Rules.



➤ Anti-Islanding Effect

- Islanding effect is a special phenomenon that grid-connected PV system still supply power to the nearby grid when the voltage loss is happened in the power system. It is dangerous for maintenance personnel and the public.
- X1 series provide Active Frequency Drift (AFD) to prevent islanding effect.











2.4 Explanation of Symbols

This section gives an explanation of all the symbols shown on the inverter and on the type label.

• Symbols on the Inverter

Symbol	Explanation
	The inverter is working normally, when the blue light is on.
	An error has occurred, when the red light is on.

• Symbols on the Type Label

Symbol	Explanation
	CE mark. The inverter complies with the requirements of the applicable CE guidelines.
	TUV certified.
	RCM mark.
	SAA certification.
	Beware of hot surface. The inverter can become hot during operation. Avoid contact during operation.
	Danger of high voltages. Danger to life due to high voltages in the inverter!
	Danger. Risk of electric shock!
	Observe enclosed documentation.
	The inverter can not be disposed together with the household waste. Disposal information can be found in the enclosed documentation.
	Do not operate this inverter until it is isolated from battery, mains and on-site PV generation suppliers.
	Danger to life due to high voltage. There is residual voltage in the inverter which needs 5 min to discharge. • Wait 5 min before you open the upper lid or the DC lid.

3 Introduction

3.1 Basic features

Congratulations on your purchase of a X1 Series inverter from SolaxPower company.

The X1 Series inverter is one of the finest inverter on the market nowadays, incorporating state-of-the-art technology, cost-effective, high reliability.

- Optimal MPPT technology.
- Advanced anti-islanding solutions.
- Excellent protections.
- IP 65 protection level.
- Efficiency up to 97%.
- THD < 2%.
- Power factor regulation.
- Safe & Reliable: transformer-less design with software and hardware protection.
- Friendly HMI.
 - LED status indications.
 - LCD display technical data, Human-machine interaction through press key.
 - RS 485 communication interface.
 - Remote upgrade and upgrade from USB.
 - Energy conservation.
 - Pocket WiFi/LAN/GPRS/WiFi Plus.

3.2 Terminals of PV Inverter

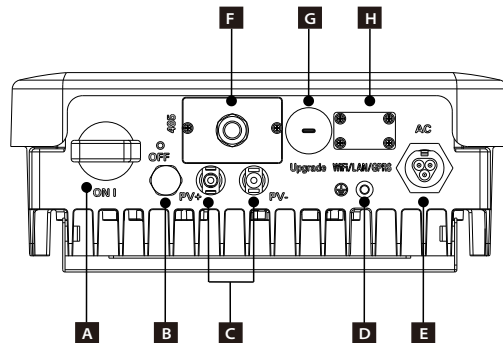

Object	Description
A	DC Switch (optional)
B	Waterproof Lock Valve
C	DC Connector
D	Ground Screw
E	AC Connector
F	RS 485/DRM/Meter
G	USB for Update
H	Pocket WiFi/LAN/GPRS (optional)

Note:

Pocket WiFi/LAN/GPRS share one port H; RS485/Meter/DRM share one port F.



WARNING!

Only authorized personnel is allowed to set the connection.

3.3 Dimension

➢ Dimension

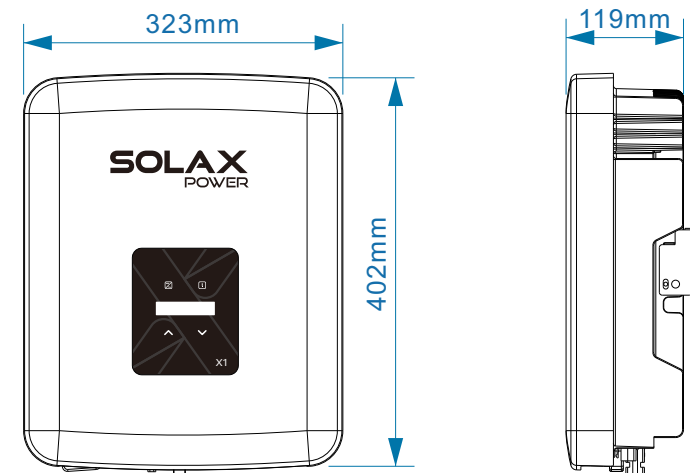

4 Technical Data

4.1 DC Input

Model	X1-2.5-S-D	X1-3.0-S-D	X1-3.3-S-D
	X1-2.5-S-N	X1-3.0-S-N	X1-3.3-S-N
Max.PV Input Power	2700W	3200W	3450W
Max.PV Voltage	600V	600V	600V
Nominal Voltage	360V		
MPPT Voltage Range	70~580V	70~580V	70~580V
Max.PV Current	10A	10A	10A
ISC PV	12A	12A	12A
MAX. inverter backfeed current to the array	0A		
Start input voltage	65V		
Start output voltage	80V		
MPPT Tracking No.	1		
No. of PV Input	1		

4.2 AC Output

Model	X1-2.5-S-D	X1-3.0-S-D	X1-3.3-S-D
	X1-2.5-S-N	X1-3.0-S-N	X1-3.3-S-N
Rated Output Power	2500VA	3000VA	3300VA
Max.Output Power	2500VA	3000VA	3300VA
On-grid Connection	Single-Phase		
Voltage Range	180-280V		
Nominal Voltage	220/230/240V		
Max.Output Current	12A	14A	15A
Maximum Output fault current	24.7A		
Max Output Overcurrent Protection	33A		
Inrush Current	92A		
Frequency Range	45-55/55-65 Hz		
Nominal Frequency	50/60Hz		
Power Factor	0.8leading~0.8lagging		
Total Harmonic Distortion(THDi)	<2%		

4.3 Efficiency, Safety and Protection

Model	X1-2.5-S-D	X1-3.0-S-D	X1-3.3-S-D
	X1-2.5-S-N	X1-3.0-S-N	X1-3.3-S-N
Euro - Efficiency	96.80%	96.80%	96.80%
Max.Efficiency	97.10%	97.10%	97.10%
MPPT Efficiency	99.90%	99.90%	99.90%
Safety & Protection			
Over Voltage Protection	YES		
Over Current Protection	YES		
DC isolation Impedance Monitoring	YES		
Ground Fault Current Monitoring	YES		
DC injection Monitoring	YES		
Protective Class	Class I		

4.4 General Data

Model	X1-2.5-S-D	X1-3.0-S-D	X1-3.3-S-D
	X1-2.5-S-N	X1-3.0-S-N	X1-3.3-S-N
Dimension of Packing(W/H/D)	495*401*227mm		
Net Weight	10.5kg		
Gross Weight	12kg		
Installation	Wall-mounted		
Operating Temperature Range	-25°C~ +60°C(derating at 45°C)		
Storage Temperature	-25°C~ +60°C		
Storage/Operation Relative Humidity	0%~100%, condensation		
Altitude	≤2000m		
Protection Level	IP 65(for outdoor use)		
Isolation Type	Transformerless		
Night-time Consumption	<1W		
Cooling	Natural Cooling		
Noise Level	<25dB		
Communication Interface	Pocket WiFi Plus/LAN/GPRS/4G/LAN Port/Meter (optional)/RS485/DRM/USB		
Standard Warranty	5years (10 years optional)		
Pollution degree	II		
Over voltage category(PV/AC)	II / III		

5 Installation

5.1 Check for Transport Damage

Make sure the inverter is intact during transportation. If there are some visible damages, such as cracks, please contact your dealer immediately.

5.2 Packing List

Open the package and fetch out the product, check the accessories at first. The packing list shows as below.

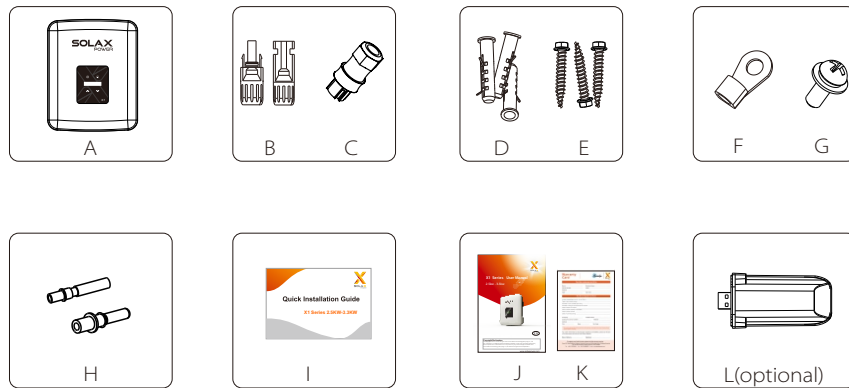

Object	Quantity	Description
A	1	X1 series inverter
B	2	DC connector
C	1	AC connector
D	3	Expansion tube
E	3	Expansion screw
F	1	Ring terminal X1
G	1	Screw bolt X1
H	1	DC pin contact(1*positive,1*negative)
I	1	Quick installation guide X 1
J	1	Product manual
K	1	Warranty card
L	1	Pocket WiFi /LAN/GPRS(optional)

5.3 Installation Precaution

X1 Series inverter is designed for outdoor installation (IP 65). Make sure the installation site meets the following conditions:

- Not in direct sunlight.
- Not in areas where highly flammable materials are stored.
- Not in potential explosive areas.
- Not in the cool air directly.
- Not near the television antenna or antenna cable.
- Not higher than altitude of about 2000m above sea level.
- Not in environment of precipitation or humidity .
- Be sure the ventilation is good enough.
- The ambient temperature in the range of -25°C to +60°C.
- The slope of the wall should be within $\pm 5^\circ$.

Please avoid direct sunlight, rain exposure, snow laying up during installing and operating.

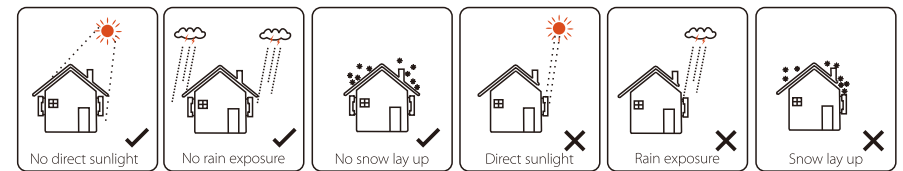

➤ Available Space Size

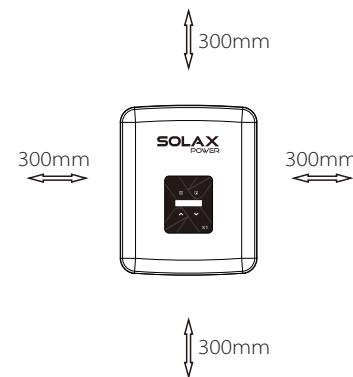

Table Available Space Size

Position	Min.size
Left	300mm
Right	300mm
Top	300mm
Bottom	300mm
Front	300mm

5.4 Installation Steps

➤ Preparation

Below tools are needed before installation.



Installation tools : crimping pliers for binding post, screwdriver, manual wrench and $\Phi 10$ driller.

➤ Step 1: Screw the wall bracket on the wall

a) The wall bracket is fixed on the inverter, and the user should remove it firstly. ($\Phi 10$ driller.torque: $0.8 \pm 0.1 \text{Nm}$).

➤ Step 2: Screw the wall bracket on the wall

b) Use the wall bracket as a template to mark the position of the 3 holes on the wall.

c) Drill holes with driller, make sure the holes are deep enough (at least 50mm) for installation, and then tighten the expansion tubes.

d) Install the expansion tubes in the holes, and tighten them. Then install the wall bracket by using the expansion screws. ($\Phi 10$ driller.torque: $0.8 \pm 0.1 \text{Nm}$)

➤ Step 3: Screw the wall bracket on the wall

e) Hang the inverter over the bracket, move the inverter close to it, slightly lay down the inverter, and make sure the 3 mounting bars on the back are fixed well with the 3 grooves on the bracket.

Note: Please refer to the details from the Quick Installation Guide.

5.5 Connection of the Inverter

5.5.1 The Main Steps to Connect to the Inverter

➤ PV String Connection

X1 series inverter have a couple of PV connector which can be connected to one-string PV modules. Please select PV modules with excellent function and reliable quality. Open circuit voltage of module array connected should be $< \text{Max.DC}$ (table as follow) input voltage : operating voltage should be within the MPPT voltage range.

Table 3 Max. DC Voltage Limitation

Model	X1-2.5-S-D X1-2.5-S-N	X1-3.0-S-D X1-3.0-S-N	X1-3.3-S-D X1-3.3-S-N
Max.DC Voltage	600V	600V	600V



WARNING!

PV module voltage is very high which belongs to dangerous voltage range, please comply with the electric safety rules when connecting.



WARNING!

Please do not make PV positive or negative ground!



NOTE!

Please follow the requirements of PV modules as below:
Same type; Same quantity; Identical alignment; Identical tilt.
In order to save cable and reduce the DC loss, we suggest installing the inverter near PV modules.

● **Connection Steps**

Below tools are needed before connection.

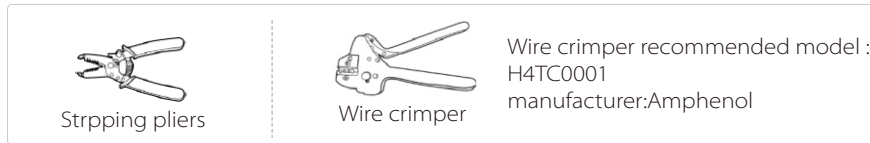

- a) Turn off the DC switch, then Choose 12 AWG wire to connect the PV module.
- b) Trip 6mm of insulation from the wire end by using the stripping pliers.

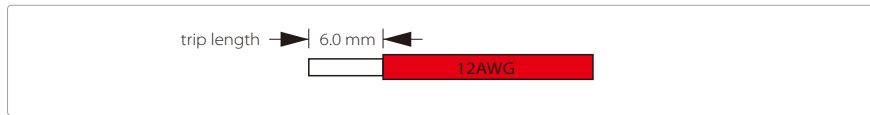

- c) Insert striped wire into pin contact and ensure all conductor strand are captured in the pin contact.



- d) Crimp pin contact by using the wire crimper.

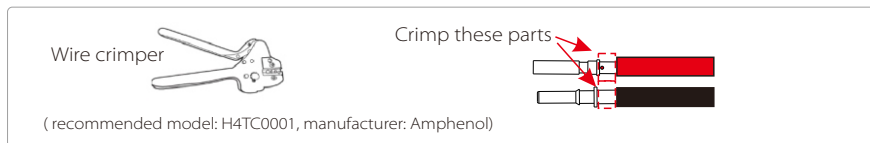

- e) Separate the DC connector as two parts: the plug and the cable nut. Then insert the wire with pin contact through the cable nut.

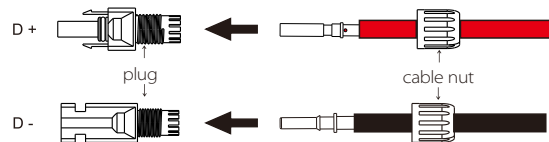

- f) Insert the wire into plug forcibly, when a "click" is heard or felt the pin contact assembly is seated correctly. Then tighten the cable nut.



➤ **Grid Connection**

X1 series inverter are designed for single phase grid. Voltage range is 220/230/240V, frequency is 50/60Hz. Other technical requests should comply with the requirement of the local public grid.

Table 4 Cable and Micro-breaker recommended

Model	X1-2.5-S-D X1-2.5-S-N	X1-3.0-S-D X1-3.0-S-N	X1-3.3-S-D X1-3.3-S-N
Cable	4-5mm ²	4-5mm ²	4-5mm ²
Micro-Breaker	20A	20A	20A

Micro-breaker should be installed between inverter and grid, any load should not be connected with inverter directly.

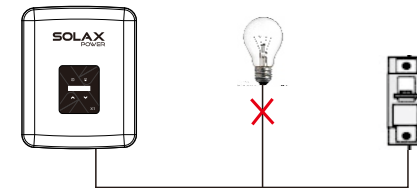

Incorrect Connection between Load and Inverter

● **Connection Steps**

- a) Check the grid voltage and compare with the permissive voltage range (refer to technical data).
- b) Disconnect the circuit-breaker from all the phases and secure against re-connection.
- c) Trip the wires:
 - Trip all the wires to 52.5mm and the PE wire to 55mm.
 - Use the crimping pliers to trip 6mm of insulation from all wire ends as below.

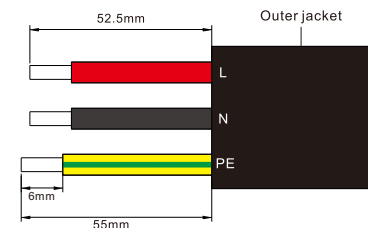

- d) Separate the AC plug into three parts as below.
 - Hold the middle part of the female insert, rotate the back shell to loose it, and detach it from female inset.
 - Remove the cable nut (with rubber insert) from the back shell.
- e) Slide the cable nut and then back shell onto the cable.

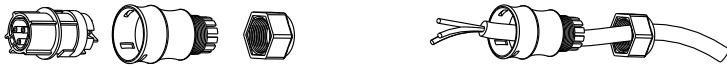

- f) Insert the tripped end of each three wires into the appropriate hole in the female insert, and then tight each screw (to tight each wire in place).(PH1 cross screwdriver .torque:0.8±0.1Nm)

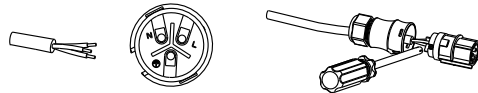

- g) Screw down the threaded sleeve the pressure screw.

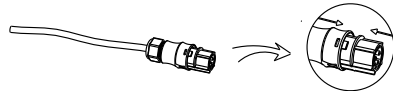

- h) Screw down the pressure screw.(torque:3±0.3Nm)

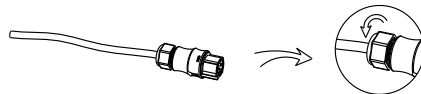

- i) Connect the AC plug to the inverter.

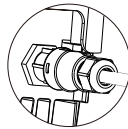

➤ Ground Connection

Screw the ground screw with allen wrench shown as follow. (φ4 hexagon wrench.torque:1.5±0.2Nm)

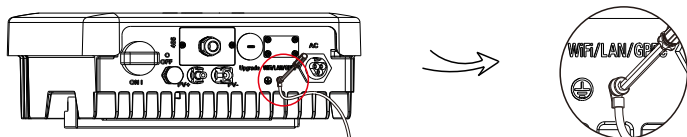

➤ WiFi Connection (optional)

You can read the real time data on the internet either from PC or smartphone with WiFi monitoring.

● Connection Step:

- a) Open the WiFi lid on the back of the inverter.
 b) Plug the Pocket WiFi (from Solax) into the port named "WiFi/LAN/GPRS" on inverter, and tighten the four screws as below.
 c) Connect the WiFi with the router. (Please refer to "WiFi Setting Guide")
 d) Set the station account on the Solax web. (Please refer to "WiFi Setting Guide")(PH2 cross screwdriver.torque:0.8±0.2Nm)

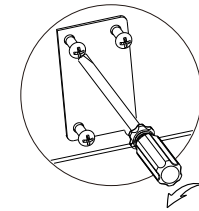

(a)

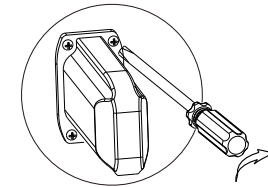

(b)

5.5.2 Communication Interface

This product has a series communication interfaces : RS 485, USB, DRM. Operating information like output voltage, current, frequency, fault information, etc., can be delivered to PC or SolaX Cloud Monitoring equipment via these interfaces.

➤ RS 485 Communication

When user wants the information of the power station and manage the entire power system. We offer RS 485 communication.



• **Communication**

a) RS 485

It is generally for inverter’s communication. System monitor should be configured to realize one PC communicates with inverter at same time. Through PC could get real time PV plants operating data.

The correspond relationship of the pins of RJ 45 and network cable color shows as below.

T568B connection order

RJ 45 Line NO.	Cable Color
1	Whight orange
2	Orange
3	White green
4	Blue
5	White blue
6	Green
7	White brown
8	Brown

Connection steps:

Cable Color	RS 485 Converter
4 Blue	A
5 White blue	B

RS 485 converter connection

Choose high-quality network cable, trip the insulation from the wire ends. For the end use for the inverter, follow T568B order with press pliers to push into the 8-wire RJ 45 crystal head. For the other end, follow the 2-wire RJ 45 crystal head to connect with the RS 485 converter connector.

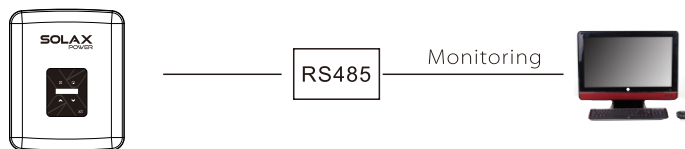

b) Meter(optional)

With this single phase meter working together with the X1 series, you can:

- (1) Monitor the energy to grid and from grid through the whole day.
- (2) Achieve the export control function with a higher accuracy.

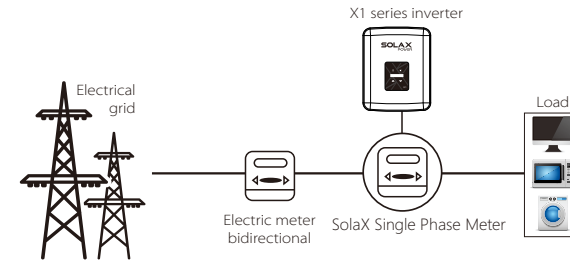

The PIN definitions of RS 485/Meter interface are as below.

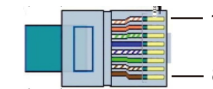

PIN	1	2	3	4	5	6	7	8
Definition	RefGen	Com/DRM0	GND_COM	Meter_A/ 485_A	Meter_B/ 485_B	E_Stop	GND_COM	X

c) DRM

DRM function (for AS4777) is provided to support several demand response modes by giving control signals as below. The user should short circuit between 1 and 2 and cooperate with external equipment when using it.

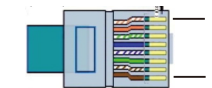

PIN	1	2	3	4	5	6	7	8
Definition	RefGen	Com/DRM0	GND_COM	X	X	X	X	X

DRM shares the terminal block with RS485/Meter communications. The connection steps of the DRM, user can refer to the above (b) RS485 connections.

Note: Only DRM0 is available now, and other functions are being developed.

➤ **RS 485/Meter/DRM Connection**

- 1) Firstly unscrew all screws from the 485 port.(PH1 cross screwdriver .torque:0.8±0.1Nm)
- 2) Prepare a communication cable and trip the insulation from it.
- 3) Let the communication cable pass though the waterproof connector, then insert it into the connector following the PIN definition rule.

Hand tighten. torque : 0.2±0. 1Nm

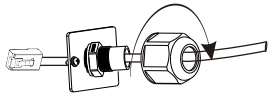

- 4) Crimp the connector with the crimping plier.
- 5) Insert the cable into the 485 port of the inverter, and tighten the waterproof connector.

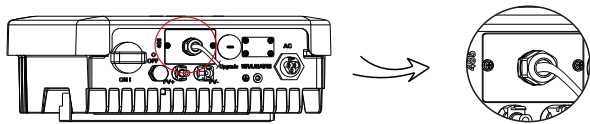

➤ **Upgrade**

User can update the inverter system through the U-disk.

WARNING!
Make sure the input voltage is more than 100V (in good illumination condition), or it may result in failing during updating.

● **Upgrade Steps:**

Please contact SolaX service to get the latest firmware. Then add a new folder named "Update" in the root directory on your U-disk, and two more sub-folders named "ARM" and "DSP" under "Update". Please copy the firmware files into ARM and DSP respectively. It will be like:
 "update\ARM\618.00207.00_X1_BOOST3.0_MINI2.0_AIR2.0_ARM_V1.10_20190828.usb;
 "update\DSP\618.00205.00_X1_BOOST3.0_MINI2.0_AIR2.0_DSP_V1.09_20190613.usb
 Press and hold the "Enter" key for 5 seconds to enter Off Mode. Then unscrew the waterproof lid and insert the U-disk into the "upgrade" port.

WARNING!
Make sure the directory is in accordance with above form strictly! Do not modify the program file name ! Or it may cause the inverter does not work anymore !

NOTE!
If the **DSP/ARM** firmware upgrade failed or stopped, please **do not** turn off the DC switch or disconnect the PV connector. Re-plug the USB drive again and continue to upgrade.

- 2) Make sure the DC switch is off and the AC is disconnected with grid. Unscrew the waterproof lid of Upgrade port by straight screwdriver as below.

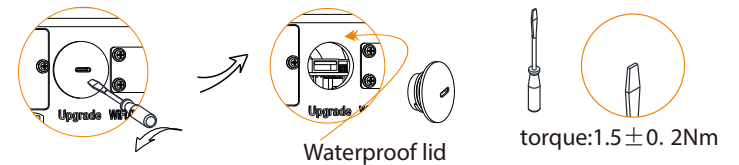

- 3) Then insert U-disk into the USB port on the bottom of the inverter. Then turn on DC switch or connect the PV connector, the LCD will show the main pictures as below.

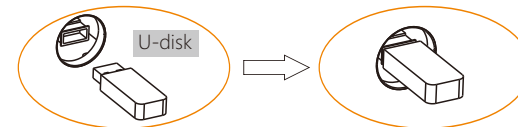
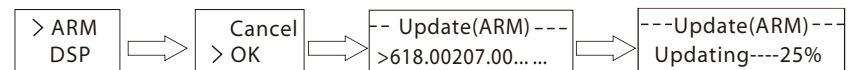

- 4) Press up and down to select the one that you want to update and long press down to confirm.

5) After the upgrade is completed, please remember to turn off the DC switch or disconnect the PV connector, then pull off the U-disk, screw the waterproof lid.



WARNING!

During updating, please don't turn off the DC switch or disconnect the PV connector. If failed, just re-plug the USB again and continue to repeat the above operation again.

➤ Isolation Fault Alarm

The isolation fault alarm installed into the inverter, is the standard configuration, as required by AS 4777.2 and AS/NZS 5033, it will give an alarm once the Insulation impedance of the PV arrays is less than 100KΩ.

5.6 Start the Inverter

5.6.1 Start the inverter after checking all below steps:

- Check that device is fixed well on the wall.
- Make sure all the DC breakers and AC breakers are disconnected.
- AC cable is connected to grid correctly.
- All PV panels are connected to inverter correctly, DC connectors which are not used should be sealed by cover.

5.6.2 Start inverter

- Turn on switches of DC and AC side.
- Inverter will start up automatically when PV panels generate enough energy.
- Check the status of LED indication and LCD screen, the LED indication should be blue and the LCD screen should display the main interface. If the LED indication is not blue, please check the below:
 - All the connections are right.
 - All the external disconnect switches are closed.
 - The DC switch of the inverter is in the "ON" position.

*The three different states of the inverter can refer to the following:

- **Waiting:** Inverter is waiting to checking when output DC voltage from PV panels is greater than 65V (lowest start-up voltage) but less than 80V (lowest operating voltage). Under this mode, the blue light "  " is flickering.

- **Checking:** Inverter will check output environment automatically when DC output voltage of PV panels. Under this mode, the blue light is flickering.

- **Normal:** Inverter begins to operate normally with blue light on. Inverter will work in MPPT mode when PV voltage is in the MPPT voltage range, inverter will stop feedback to grid when PV power is not enough. Under this mode, the blue light is always on.



WARNING!

Power to the unit must be turned on only after installation work has been completed. All electrical connections must be carried out by qualified personnel in accordance with legislation in force in the country concerned.



NOTE!

Please set the inverter if it is the first time to start up. Above steps are for the regular start of the inverter. If it is the first time to start up the inverter, you need to setup the inverter.



ENERGY CONTROL

Equipment only to be used for the purpose outlined by SolaX.

6 Operation Method

6.1 Control panel

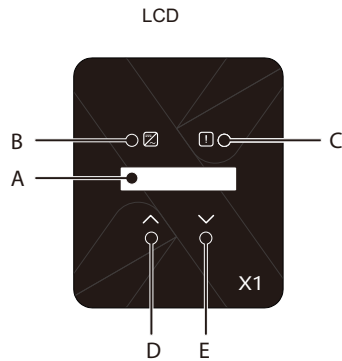

Object	Name	Description
A	LCD Screen	Display the information of the inverter.
B	Indicator LED	Light in blue: The inverter is in normal status. Flash in blue: The inverter is in waiting status.
C		Light in red: The inverter is in fault status.
D	Function Button	Up/ESC button: Move cursor to upside or increase value. Return from current interface or function
E		Down/Enter button: Move cursor to downside or decrease value. Confirm and change the parameters.

Note: When the inverter are in "Waiting" and "Checking" status, the blue light "B" is flickering; when in "Normal" status, the blue light "B" is always on.

6.2 LCD Structure

Please refer to the inverter for the most updated structure

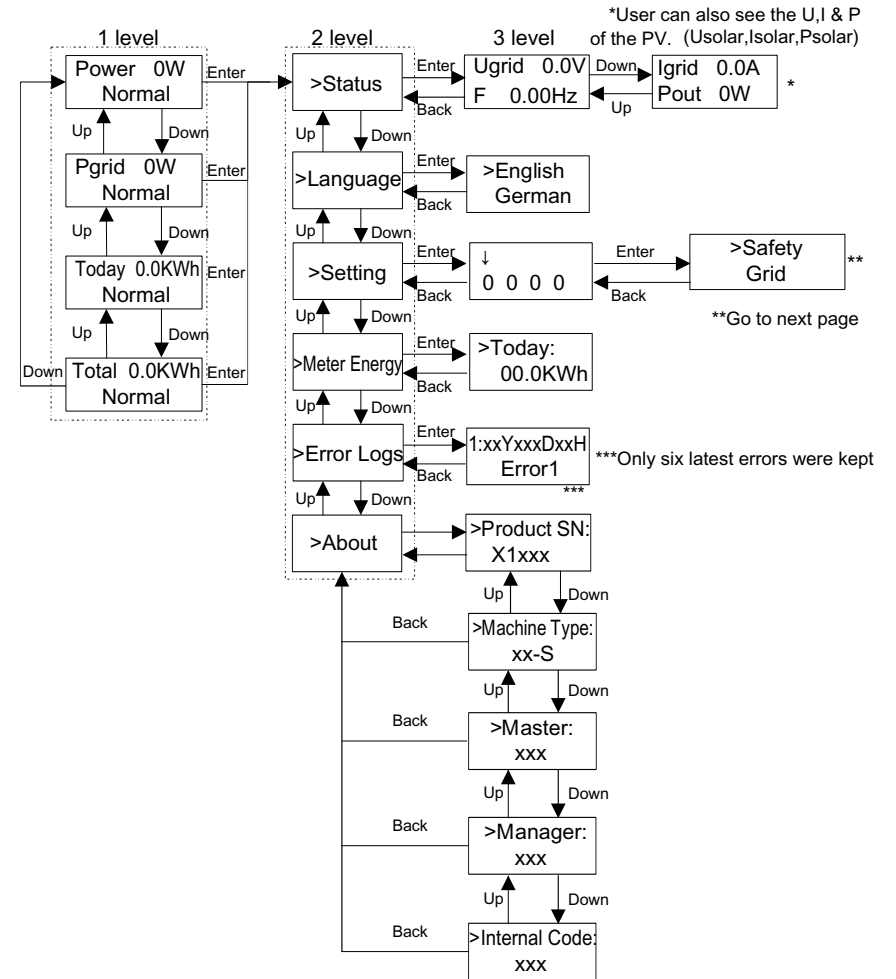

Note:

Key	Operation	Description
v Enter/Down	Long Press	Go to the next menu or confirm to change parameters
	Short Press	Look at the next parameter or increase the value
^ Back/Up	Long Press	Return the previous menu or confirm the parameters
	Short Press	Look at the previous parameter or decrease the value

6.3 LCD Operation

• Setting function is used for setting the inverter for Safety, Grid, Power Factor and so on.

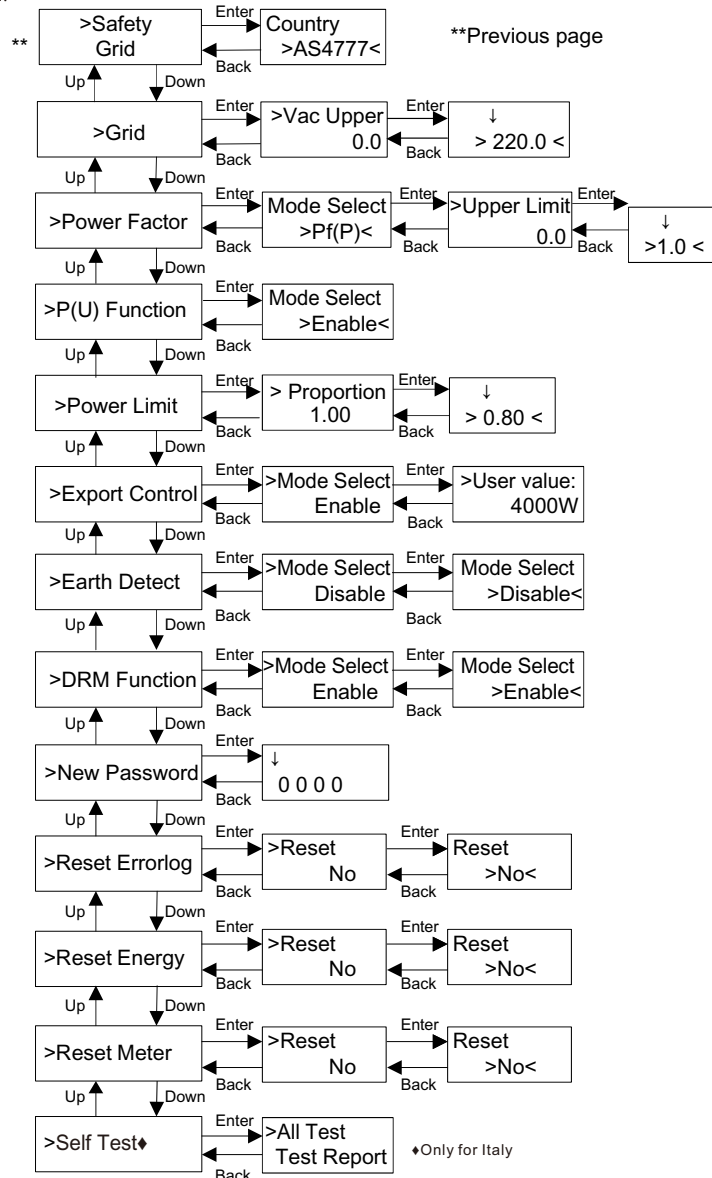

➤ LCD Display

- 1 level
 - a) The first line displays the parameters(Power,Today and Total) and the values.
 - b) The second line shows the running status.
 - Namely, "Power" means the timely output power;
 - "Pgrid" means the power export to or import from the grid;(Positive value means the energy feeds into the grid, negative value means the energy used from the grid)
 - "Today" means the power generated within the day.
 - "Normal" means the status of the inverter.

- 2 level
 - Long press any first-level parameter can enter the second-level "Status" parameter interface.
 - The user can also see other parameters, such as the Language(without password), Setting (need password), Error Logs of the inverter, and About (the user can watch the information of the inverter).

- 3 level
 - Long press the second-level parameter can enter the corresponding third-level parameter interface.

a) Status: The user can see the U/I/P parameters of the grid and the PV, such as the Ugrid, Igrid, PF value of the grid, and the Usolar, Isolar and Psolar of the PV.

b) Language: This inverter provides several languages for customer to choose.

c) Setting: Entering the installer password, the information of the LCD interface is as the previous page shown.

(1) Safety: The user can set the right safety standard here.

(2) Grid: Usually end user does not need to set the grid parameters. All default value have been set before leaving factory according to safety rules.

Parameter	Comment
Normally	
Vac upper	Voltage high protect
Vac lower	Voltage low protect
Vac upper slow	Voltage high slow protect
Vac lower slow	Voltage low slow protect
Fac upper	Frequency high protect
Fac lower	Frequency low protect
Fac upper slow	Frequency high slow protect
Fac lower slow	Frequency low slow protect
Vac 10m avg	10 min voltage high protect
Apply to EN50438_NL.	
FreqSetPoint	Frequency set point
FreqDropRate	Frequency droop rate

(3) Power Factor: (For specific country if required by the local grid.)
 There are 6 modes for selecting: Off , Under-Excited, Over-Excited, PF(p), Q(u).
 All parameters are shown below.

Mode	Comment
Off	-
Under-Excited	PF value
Over-Excited	PF value
PF(p)	Upper limit
	Lower limit
	Power Upper
	Power Lower
Q(u)	QuVupRate (EN50549_NL)
	QuVlowRate (EN50549_NL)
	QURangeV1 (AS4777.2)
	QURangeV4 (AS4777.2)
Fixed Q Power	Q Power(for some local grids)

For VDE ARN 4105, curve $\cos \phi = f(P)$ should refer to curve A. default values of setting are as shown in curve A.
 For E 8001, curve $\cos \phi = f(P)$ should refer to curve B. default values of setting are as shown in curve B.

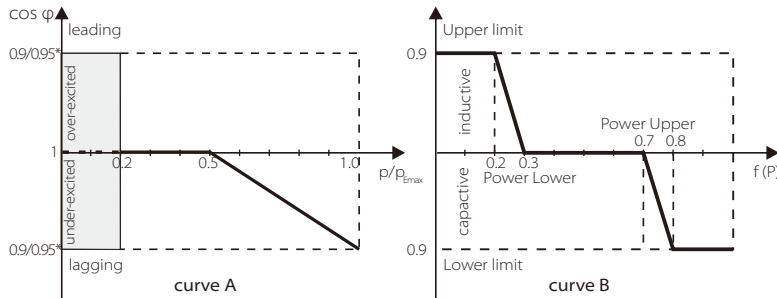

Reactive power control, Reactive standard curve $Q = f(V)$

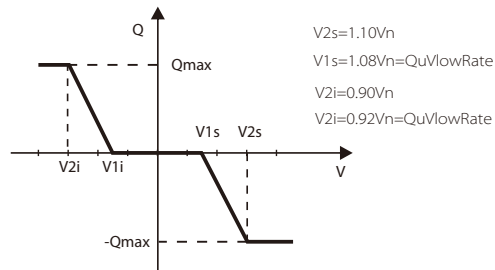

→The way to operate the value :
 a) Just watch the parameter of the mode by short pressing (Λ) and (V) .
 b) If you change other mode by short pressing (Λ) and (V) , you need return the Power Factor interface by long pressing the (V). Then short press (V) to confirm and enter the Upper Limit. This time you can modify the value by long pressing (Λ) ; If you only change the parameter of the mode(default), you just long press the (Λ) to modify the value.
 c) After setting, long press the (V) key to confirm and return the previous directly.

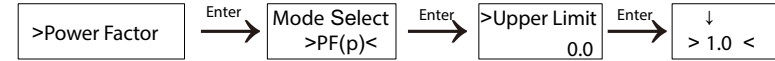

(4) P(u) Function: The device is suitable for Australia if the "Enable" is chosen.

(5) Power limits: User can set the power limit value of the inverter, and the default is 1. If you want to change, please refer to the method bellow. (the same operation to other setting value)

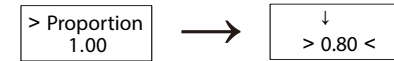

→The way to set value :
 a) Long press the key (V) to enter the interface, and long press again to modify .
 b) Short Press (Λ) or (V) to increase or decrease the value you needed.
 c) After setting, long press the (V) key to confirm the parameters or you can long press the (Λ) to confirm and return the previous directly.

(6) Export Control: With this function the inverter can control energy exported to the grid. Choose "Enable" in Mode Select means user must install a solax meter or ct to monitor energy exported to the grid. Choose "Disable" means the function will be shut off.

To set No Feed In to the Grid, please change the user value to 0.

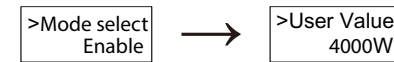

(7) Earth Detect: The default is "Disabled". If turned on, the inverter will occur an error

(8) DRM Function: User can choose whether using the DRM function or not.

(9) New Password: Installer can set the new password here.

→The way to set password:
 a) Long press the key (V) to enter the interface, and long press again to modify .
 b) Short Press (Λ) or (V) to increase or decrease the value you needed.
 c) After setting, long press the (V) key to confirm the parameters.
 d) Long press (Λ) to enter next level.

(10) Reset Errorlog: The user can clear the errorlogs by this function.

(11) Reset Energy: The user can clear the power energy by this function.

(12) Reset Meter: The user can clear the Meter energy by this function.

(13) Self Test(only for CEI 0-21): User can test operating staus of inverter by choosing "All Test". When testing OK, the inverter will restart again and user can see the result from the "Test Report".

(14) About: This interface shows information of the inverter, include product serial number, machine type, master, manager and internal code.

7 Troubleshooting

7.1 Troubleshooting

This section contains information and procedures for solving possible problems with the X1 series inverter, and provides some troubleshooting tips to identify and solve most problems that could occur with X1 series inverter.

This section will help you narrow down the source of any problems you may encounter. Please read the following troubleshooting steps.

Check the indicator light state. Record it before anything further solutions. Attempt the solution indicated in troubleshooting list.

If the indicator lamp unlit, check the following list to make sure that the present state of the installation allows proper operation.

- Is the inverter located in a clean, dry, adequately ventilated place?
- Have the DC input breakers been opened?
- Are the cables adequately sized and short enough?
- Are the communication cable properly connected and undamaged?

Please contact SolaX Power company customer service for further assistance. Please be prepared to describe details of your system installation and provide the model and serial number of the unit.

Troubleshooting List

Fault	Description
PV Volt Fault	- Check the panel's open circuit voltage whether the value is similar or already >Max. DC voltage. - Please seek help from us when voltage \leq Max. DC voltage.
Isolation Fault	- Check the connection of the inverter. - Or seek help from us, if can not go back to normal state.
Temp Over Fault	- Check the connection of the inverter. - Or seek help from us, if can not go back to normal state.
DCI Fault	- Check the connection of the inverter. - Or seek help from us, if can not go back to normal state.
Earth Fault	- Check the connection of the inverter. - Check whether the enable switch of Earth Detect is on. - Or seek help from us, if can not go back to normal state.
Meter Fault	- Check the connection of the inverter. - Check whether the enable switch of Export Control is on. - Or seek help from us, if can not go back to normal state.

Fault	Description
RCD Fault	Leakage current detection circuit Fault. - Disconnect PV+, PV-, reconnect them. - Or seek help from us, if can not go back to normal state.
Mains Lost	Off to grid. - Please check grid-connection, like wire, interface, etc. - Checking grid usability. - Or seek help from us, if can not go back to normal state.
Grid Volt Fault	Grid voltage out of range. - System will reconnect if the utility is back to normal. - Or seek help from us, if can not go back to normal state.
Grid Freq Fault	Grid frequency out of range. - System will reconnect if the utility is back to normal. - Or seek help from us, if can not go back to normal state.
Consistant Fault	- Disconnect PV+, PV-, reconnect them. - Or seek help from us, if can not go back to normal state.
Relay Fault	Relay is failure between grid and inverters. - Disconnect PV+, PV-, reconnect them. - Or seek help from us, if can not go back to normal state.
EEPROM Fault	Eeprom Fault. - Disconnect PV+, PV-, reconnect them. - Or seek help from us, if can not go back to normal state.
Comms Lost	- Disconnect PV+, PV-, reconnect them. - Or seek help from us, if can not go back to normal state.
Bus Volt Fault	Bus voltage out of normal range. - Disconnect PV+, PV-, reconnect them. - Check if the PV input is within the range of the inverter. - Or seek help from us, if can not go back to normal state.
TZ Fault	Over current fault. - Disconnect PV+, PV-, reconnect them. - Or seek help from us, if can not go back to normal state.
Other Device Fault	Else. - Seek help from us.

Fault	Description
AC10Min Volt Fault	AC10Minute overvoltage Fault. - System will reconnect if the utility is back to normal. - Or seek help from us, if can not go back to normal state.

7.2 Maintenance

To ensure that the X1-Air can operate properly for a long term, you are advised to perform routine maintenance on it. Before cleaning the system, connecting cables, and maintaining the grounding reliability, power off the system.



WARNING!

Only trained and authorized professional personnel who are familiar with the requirements of safety are allowed to perform servicing and maintenance work.

➤ Safety Checks

Safety checks should be performed at least every 12 months by manufacture's qualified person who has adequate training, knowledge, and practical experience to perform these tests. The data should be recorded in an equipment log. If the device is not functioning properly or fails any of test, the device has to be repaired.

➤ Maintain periodically

Only qualified person may perform the following works. During the process of using the inverter, the manage person shall examine and maintain the machine regularly. The concrete operations are follow.

- 1) Check that if the cooling fins on the rear of house are covered by dirts, and the machine should be cleaned and absorbed dust when necessary. This work shall be check time to time.
- 2) Check that if the input and output wires are damaged or aged. This check should be performed at least every 6 months.
- 3) The inverter panels should be cleaned and security checked every 6 months at least.
- 4) Check whether the ground terminal and ground cable are securely connected and all terminals and ports are properly sealed every 12 months.

8 Decommissioning

8.1 Decommissioning

Disconnect the inverter from DC input and AC output.
 Remove all connection cables from the inverter.
 Remove the inverter from the bracket.

If possible, please pack the inverter with the original packaging. If it is no longer available, you can also use an equivalent carton that meets the following requirements.

Suitable for loads more than 30kg.
 With handle.
 Can be fully closed.

8.2 Storage and Transportation

Store the inverter in dry place where ambient temperature are always between $-25^{\circ}\text{C} \sim +60^{\circ}\text{C}$. Take care of the inverter during the storage and transportation, keep less than 4 cartoons in one stack.

8.3 Disposal

Please be sure to deliver wasted inverter and packing materials to certain site, where can assist relevant department to dispose to and recycle.